

PALMARY PRODUCTS

- Centerless Grinder
- Cylindrical Grinder
- Internal Grinder
- Vertical Grinder
- Surface Grinder
- Special Purpose Grinder

PALMARY
A Total Dedication to New Technological Level



HIGH PRECISION CYLINDRICAL GRINDER
S Series / NC Series



PALMARY MACHINERY CO., LTD.

No. 77, Gongye Rd., Dali Dist.
Taichung City 41280, Taiwan.
Tel: +886-4-2492-9799
Fax: +886-4-2492-9499
E-mail: palmmary@grinding.com.tw
www.palmmary.com



1811N5



Precise, Perfect and Excellent



Maximum Flexibility PALMARY Cylindrical Grinder State-of-the-art Technology Your Right Choice!

“Advanced NC Control for User-friendly Operation”

- The wheel head feed on the NC series machine is driven by servomotor combined with NC control assuring maximum operational convenience.
- Humanified operation, conversational control and program-editing-free feature superb operational convenience.
- Easy to set sizes for new parts - saves 1/3 of time compared with conventional setting. Feed amount and feed rate are easy to set as desired.
 - Suitable for small batch production with increased efficiency of over 30%.
- Allows direct change to automatic feed once manual feed is accomplished - without changing program.
 - Available to set for straight plunge grinding and traverse grinding.

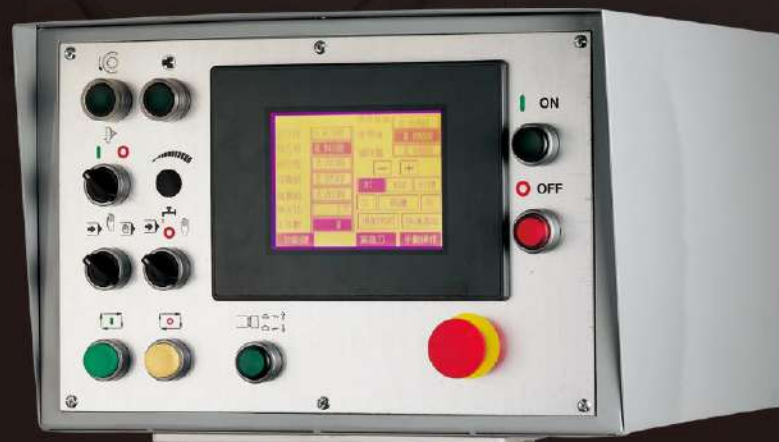

Stable and Rigid Spindle Head

- The spindle runs on precision bearings, assuring maximum spindle stability. It guarantees outstanding accuracy for external and internal diameter grinding and face grinding.
- The spindle head swivels +90° ~ -30°.
- The spindle head on the 20 series machines provides variable speed changed by frequency inverter.
- The spindle head on the 32 and 42 series is driven by servomotor, providing variable speed.

“ PALMARY high precision cylindrical grinders are unmatched in structural rigidity and stability, grinding accuracy and operational convenience. Each machine provides maximum operational flexibility thereby allowing for various grinding operations. You will get extra value when putting a PALMARY cylindrical grinder on your production line. ”

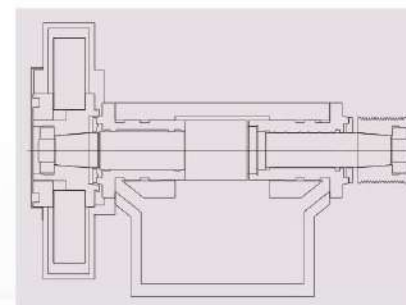

Precision Wheel Head

- The grinding wheel spindle is precision machined from high quality alloy steel SNCM-220, normalized, tempered, carburized and sub-zero treated, precision ground and mirror-effect treated. Hardness reaches to over HRC 62°. No deformation, maximum wear resistance and lifetime accuracy are assured.

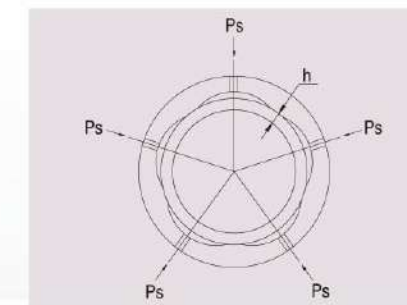

Special Hydrostatic Bearing

- The wheel spindle runs by using a special hydrostatic bearing and is especially ideal for precision grinding work. It features high speed, no friction between metals, no heat generation, deformation-free, extra high accuracy and continual use.

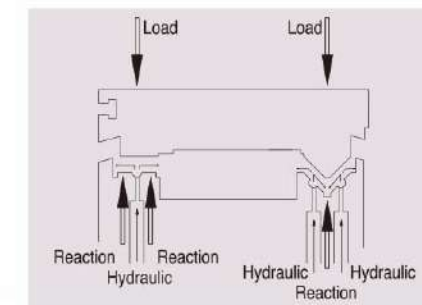

Advanced Hydrostatic Lubrication System

- The slideways of the table and the wheel head are lubricated by an advanced automatic hydrostatic lubrication system. This provides various features, such as extremely smooth movement, added feed accuracy and superior grinding accuracy.

Example of Grinding Workpieces



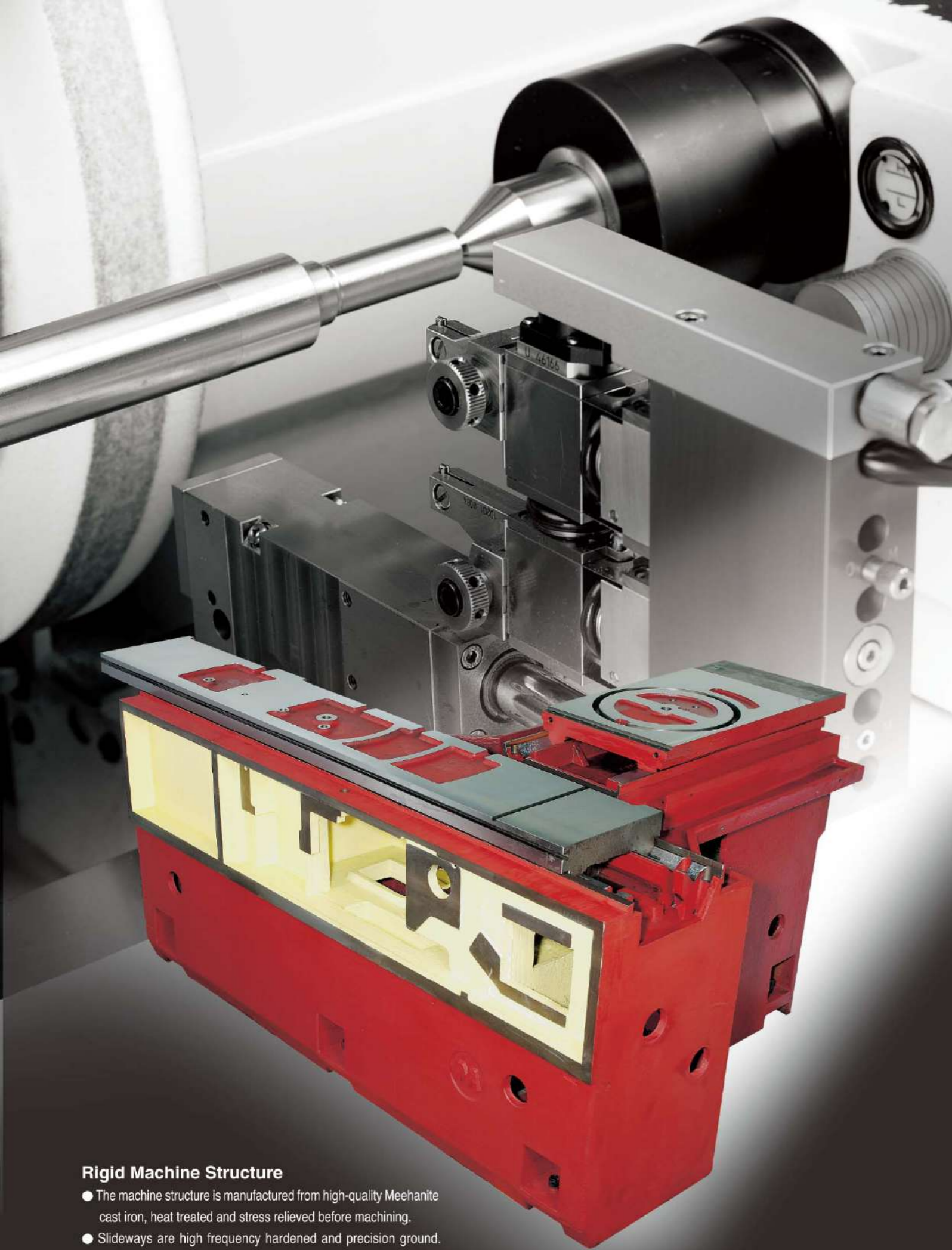

Care to Every Detail Insist on Quality! PALMARY Cylindrical Grinders

“Based on PALMARY's tradition of "Pursuing Quality Perfection", combined with human engineering design and peak performance concepts, each machine fully reflects PALMARY's unmatched design and technique. In addition, PALMARY's rigorous quality control gives added assurance of superior quality.”

Grinding Examples

● A grinder allows for various grinding applications with changeover ease.



Straight Plunge Grinding

● For small lot production, use automatic feed combined with sparkout timer to achieve superior grinding quality. For mass production, use 2-step automatic feed and 2-step automatic measurement device (optional) for upgrading productivity and grinding quality.



Shoulder Grinding

● Provides workpiece outside diameter and shoulder grinding accomplished at a time.
● Easy to set up. Simply clamp the workpiece between two centers, mount the grinding wheel on the right side of wheel head and swivel the head to a degree for performing grinding.



Traverse Grinding

● Use automatically intermittent feed combined with hydraulic drive of table for the most effective traverse grinding operations.



End Surface Grinding

● Dismantle the spindle head cover. Mount a 3-jaw or 4-jaw chuck. Change position of the pin for chuck rotation. Position the pin at a 90 degree angle for end surface grinding.



Taper Grinding

● Hold the workpiece by a chuck or two centers. The table and the wheel head can be easily adjusted and swiveled.



Internal Grinding

● To proceed with internal grinding with a hinge-type internal grinding attachment (optional accessory), simply pull down the internal grinding spindle and fix it in place.

Rigid Machine Structure

- The machine structure is manufactured from high-quality Meehanite cast iron, heat treated and stress relieved before machining.
- Slideways are high frequency hardened and precision ground. Maximum material stability for deformation-free and outstanding wear resistance.

Wheel forming device (For NC model, with auto compensation) (Optional)

The device functions as the manual wheel forming device. It further employs an automatic hydraulic unit, and compensation parameters are able to be set during operation (driven by motor) for fast grinding compensation. The device can be equipped with NC models.

Wheel forming device (Manual type, without auto compensation) (Optional)

The device is located above the wheel and driven by a hydraulic unit to slide in longitudinal direction. It is equipped with a diamond tool for dressing and a forming board for profiling. These operations are accomplished without moving the working table. The device is compatible with all series of cylindrical grinders.

High Precision
Cylindrical Grinder
NC Controlled Series

GU20x40NC

- Distance between centers 400 mm.
- Swing over table 200 mm.
- Max. grinding diameter Ø180 mm.
- NC computer controlled combined with conversational operation control for maximum operation convenience.
- Variable spindle speed 10 ~ 300 rpm.
- Automatic feed is driven by servomotor.
- Hydraulically operated traverse feed.



SPECIFICATIONS	GU20x40NC	SPECIFICATIONS	GU20x40NC
Capacity		Tailstock	
Distance Between Centers	400 mm	Center Taper	MT:3
Swivel Over Table	200 mm	Stroke	20 mm
Max. Load of Centers	60 kgs	Table	
Max. External Grinding Diameter	180 mm	Swivel Angle	-3°, +12°
Wheel Head		Traverse Speed	50 / 5400 mm/min
Swivel Angle	±30°	Auto. Reciprocate Min. Stroke	8 mm
Manual Distance	135 mm	Feed of One Turn of Handwheel (2-step)	20 mm (2 mm)
Auto Rapid Advance	25 mm	Motor	
Sliding Seat Supplementary Displacement	95 (total 255 mm)	Wheel Spindle	2.2 kw (4 P)
Min. Settling Unit	0.001 mm	Workhead Spindle	0.37 kw (4 P)
One Turn of Handwheel (graduation)	2 (0.005) mm	Hydraulic Pump	0.37 kw (4 P)
Grinding Wheel		Wheel Spindle Lubrication Pump	0.18 kw (4 P)
O.D. x Width x I.D.	355 x 38 x 127 mm	Coolant Pump	0.18 kw (2 P)
Speeds (belt-type) r.p.m.	2085 / 2495	Internal Grinding Spindle	0.18 kw (2 P)
Work Spindle Head		Tank Capacity	
Swivel Angle	120° (+90°, -30°)	Wheel Spindle Lubricant Tank	7ℓ
Center Taper	MT:3	Hydraulic Fluid Tank	46ℓ
Spindle Speeds (variable) r.p.m.	10 ~ 300	Coolant Tank	110ℓ
Max. Load of Spindle (tool holder included)	15 kgs (Max length: 100 mm)	Machine Weight	
		kgs	2000 kgs

• The mentioned specifications & dimensions are subject to change without notice.

High Precision
Cylindrical Grinder
NC Controlled Series

GU32x60NC

- Swing over table 320 mm.
- Max. grinding diameter Ø300 mm.

GU42x60NC

- Swing over table 420 mm.
- Max. grinding diameter Ø400 mm.

- Common Features:**
- Distance between centers: 600 mm.
 - NC computer controlled combined with conversational operation control for maximum operational convenience.
 - Various spindle speed 10 ~ 300 rpm, driven by servomotor.
 - Automatic feed is driven by servomotor.
 - Hydraulically operated traverse feed.



SPECIFICATIONS	GU32/42x60NC	SPECIFICATIONS	GU32/42x60NC
Capacity		Tailstock	
Distance Between Centers	600 mm	Center Taper	MT:4
Swivel Over Table	320 mm / 420 mm	Stroke	25 mm
Max. Load of Centers	100 kgs / 150kgs	Table	
Max. External Grinding Diameter	300 mm / 400 mm	Swivel Angle	-2°, +10°
Wheel Head		Traverse Speed	50 / 5400 mm/min
Swivel Angle	±30°	Auto. Reciprocate Min. Stroke	8 mm
Manual Distance	160 mm	Feed of One Turn of Handwheel (2-step)	20 mm (2 mm)
Auto Rapid Advance	40 mm	Motor	
Sliding Seat Supplementary Displacement	95 (total 295 mm)	Wheel Spindle	3.7 kw (4 P)
Min. Settling Unit	0.001 mm	Workhead Spindle	0.85 kw
One Turn of Handwheel (graduation)	2 (0.005) mm	Hydraulic Pump	0.37 kw (4 P)
Grinding Wheel		Wheel Spindle Lubrication Pump	0.18 kw (4 P)
O.D. x Width x I.D.	405 x 50 x 127 mm	Coolant Pump	0.18 kw (2 P)
Speeds (belt-type) r.p.m.	1783 / 1940	Internal Grinding Spindle	0.75 kw (2 P)
Work Spindle Head		Tank Capacity	
Swivel Angle	120° (+90°, -30°)	Wheel Spindle Lubricant Tank	9ℓ
Center Taper	MT:4	Hydraulic Fluid Tank	46ℓ
Spindle Speeds (variable) r.p.m.	10 ~ 300	Coolant Tank	110ℓ
Max. Load of Spindle (tool holder included)	35 kgs (Max length: 150 mm)	Machine Weight	
		kgs	2600 kgs / 2800 kgs

• The mentioned specifications & dimensions are subject to change without notice.

High Precision
Cylindrical Grinder
NC Controlled Series

GU32x100NC GU32x150NC GU32x200NC

- Swing over table 320 mm.
- Max. grinding diameter Ø300 mm.

GU42x100NC GU42x150NC GU42x200NC

- Swing over table 420 mm.
- Max. grinding diameter Ø400 mm.

- Common Features:**
- Distance between centers: 1,000 mm, 1,500 mm, 2,000 mm.
 - NC computer controlled combined with conversational operation control for maximum operational convenience.
 - Various spindle speed 10 ~ 300 RPM, driven by servomotor.
 - Automatic feed is driven by servomotor.
 - Hydraulically operated traverse feed.



SPECIFICATIONS	GU32/42x100NC / GU32/42x150NC / GU32/42x200NC	SPECIFICATIONS	GU32/42x100NC / GU32/42x150NC / GU32/42x200NC
Capacity		Tailstock	
Distance Between Centers	1000 mm, 1500 mm, 2000 mm	Center Taper	MT:4
Swivel Over Table	320 mm / 420 mm	Stroke	25 mm
Max. Load of Centers	100 kgs / 150 kgs	Table	
Max. External Grinding Diameter	300 mm / 400 mm	Swivel Angle	-3°, +8° (100 Type); -3°, +7° (150 Type); -1°, +7° (200 Type)
Wheel Head		Traverse Speed	50 / 5400 mm/min
Swivel Angle	±30°	Auto. Reciprocate Min. Stroke	8 mm
Manual Distance	160 mm	Feed of One Turn of Handwheel (2-step)	20 mm (2 mm)
Auto Rapid Advance	40 mm	Motor	
Sliding Seat Supplementary Displacement	95 (total 295 mm)	Wheel Spindle	3.7 kw (4 P)
Min. Settling Unit	0.001 mm	Workhead Spindle	1.3 / 2.0 kw
One Turn of Handwheel (graduation)	2 (0.005) mm	Hydraulic Pump	0.37 kw (4 P)
Grinding Wheel		Wheel Spindle Lubrication Pump	0.18 kw (4 P)
O.D. x Width x I.D.	405 x 50 x 127 mm	Coolant Pump	0.18 kw (2 P)
Speeds (belt-type) r.p.m.	1783 / 1940	Internal Grinding Spindle	0.75 kw (2 P)
Work Spindle Head		Tank Capacity	
Swivel Angle	120° (+90°, -30°)	Wheel Spindle Lubricant Tank	9ℓ
Center Taper	MT:4	Hydraulic Fluid Tank	46ℓ
Spindle Speeds (variable) r.p.m.	10 ~ 300	Coolant Tank	110ℓ
Max. Load of Spindle (tool holder included)	35 kgs (Max length: 150 mm)	Machine Weight	
		kgs	3200 kgs / 3400 kgs / 4100 kgs / 4300 kgs / 6000 kgs / 6200 kgs

• The mentioned specifications & dimensions are subject to change without notice.

High Precision
Cylindrical Grinder
Economic Series

GU20x40S

- Distance between centers 400 mm.
- Swing over table 200 mm.
- Max. grinding diameter Ø180 mm.
- Variable spindle speed 10 ~ 300 rpm. Frequency inverter control type.
- Semi-auto feed. Hydraulically operated traverse moving.
- Wheel head provides rapid feed and manual feed for grinding.



High Precision
Cylindrical Grinder
Economic Series

GU32x60S

- Swing over table 320 mm.
- Max. grinding diameter Ø300 mm.

GU42x60S

- Swing over table 420 mm.
- Max. grinding diameter Ø400 mm.

- Common Features:**
- Distance between centers: 600 mm.
 - Variable spindle speed 10 ~ 300 rpm, driven by servomotor.
 - Semi-auto feed. Hydraulically operated traverse moving.
 - Wheel head provides rapid feed and manual feed for grinding.



SPECIFICATIONS	GU20x40S	SPECIFICATIONS	GU20x40S
Capacity		Tallstock	MT:3
Distance between Centers	400 mm	Taper Center	20 mm
Swivel Over Table	200 mm	Stroke	
Max. Load of Centers	60 kgs	Table	
Max. External Grinding Diameter	180 mm	Swivel Angle	-3°, +12°
Wheel Head		Traverse Speed	50 / 5400 mm/min
Swivel Angle	±30°	Auto. Reciprocate Min. Stroke	8 mm
Manual Distance	135 mm	Feed of One Turn of Handwheel (2-step)	20 mm (2 mm)
Auto Rapid Advance	25 mm	Motor	
Sliding Seat Supplementary Displacement	95 (total 255 mm)	Wheel Spindle	2.2 kw (4 P)
Min. Setting Unit (Micro-adjust)	0.001 mm	Workhead Spindle	0.37 kw (4 P)
One Turn of Handwheel (graduation)	2 (0.005) mm	Hydraulic Pump	0.37 kw (4 P)
Grinding Wheel		Wheel Spindle Lubrication Pump	0.18 kw (4 P)
O.D. x Width x I.D.	355 x 38 x 127 mm	Coolant Pump	0.18 kw (2 P)
Speeds (belt type) r.p.m.	2085 / 2495	Internal Grinding Spindle	0.18 kw (2 P)
Work Spindle Head		Tank Capacity	
Swivel Angle	120° (+90°, -30°)	Wheel Spindle Lubricant Tank	7ℓ
Center Taper	MT:3	Hydraulic Fluid Tank	63ℓ
Spindle Speeds (variable) r.p.m.	10 ~ 300	Coolant Tank	110ℓ
Max. Load of Spindle (tool holder included)	15 kgs (Max length: 100 mm)	Machine Weight	
		Kgs	2000 kgs

SPECIFICATIONS	GU32/42x60S	SPECIFICATIONS	GU32/42x60S
Capacity		Tallstock	MT:4
Distance between Centers	600 mm	Taper Center	25 mm
Swivel Over Table	320 mm / 420 mm	Stroke	
Max. Load of Centers	100 kgs / 150kgs	Table	
Max. External Grinding Diameter	300 mm / 400 mm	Swivel Angle	-2°, +10°
Wheel Head		Traverse Speed	50 / 5400 mm/min
Swivel Angle	±30°	Auto. Reciprocate Min. Stroke	8 mm
Manual Distance	160 mm	Feed of One Turn of Handwheel (2-step)	20 mm (2 mm)
Auto Rapid Advance	40 mm	Motor	
Sliding Seat Supplementary Displacement	95 (total 295 mm)	Wheel Spindle	3.7 kw (4 P)
Min. Setting Unit (Micro-adjust)	0.001 mm	Workhead Spindle	0.85 kw / 1.3 kw
One Turn of Handwheel (graduation)	2 (0.005) mm	Hydraulic Pump	0.37 kw (4 P)
Grinding Wheel		Wheel Spindle Lubrication Pump	0.18 kw (4 P)
O.D. x Width x I.D.	405 x 50 x 127 mm	Coolant Pump	0.18 kw (2 P)
Speeds (belt type) r.p.m.	1783 / 1940	Internal Grinding Spindle	0.75 kw (2 P)
Work Spindle Head		Tank Capacity	
Swivel Angle	120° (+90°, -30°)	Wheel Spindle Lubricant Tank	7ℓ
Center Taper	MT:4	Hydraulic Fluid Tank	63ℓ
Spindle Speeds (variable) r.p.m.	10 ~ 300	Coolant Tank	110ℓ
Max. Load of Spindle (tool holder included)	35 kgs (Max length: 150 mm)	Machine Weight	
		Kgs	2600 kgs / 2800 kgs

• The mentioned specifications & dimensions are subject to change without notice.

High Precision
Cylindrical Grinder
Economic Series

GU32x100S GU42x100S

- Swing over table 320 mm.
- Max. grinding diameter Ø300 mm.
- Swing over table 420 mm.
- Max. grinding diameter Ø400 mm.

- Common Features:**
- Distance between centers: 1,000 mm.
 - Variable spindle speed 10 ~ 300 rpm, driven by servomotor.
 - Semi-auto feed. Hydraulically operated traverse moving.
 - Wheel head provides rapid feed and manual feed for grinding.



High Precision
Cylindrical Grinder
Economic Series

**GU32x150S GU42x150S
GU32x200S GU42x200S**

- Swing over table 320 mm.
- Max. grinding diameter Ø300 mm.
- Swing over table 420 mm.
- Max. grinding diameter Ø400 mm.

- Common Features:**
- Distance between centers: 1,500 mm, 2,000 mm.
 - Variable spindle speed 10 ~ 300 rpm, driven by servomotor.
 - Semi-auto feed. Hydraulically operated traverse moving.
 - Wheel head provides rapid feed and manual feed for grinding.



SPECIFICATIONS	GU32/42x100S	SPECIFICATIONS	GU32/42x100S
Capacity		Tailstock	
Distance between Centers	1000 mm	Taper Center	MT:4
Swivel Over Table	320 mm / 420 mm	Stroke	25 mm
Max. Load of Centers	100 kgs / 150 kgs	Table	
Max. External Grinding Diameter	300 mm / 400 mm	Swivel Angle	-3°, +8°
Wheel Head		Traverse Speed	50 / 5400 mm/min
Swivel Angle	±30°	Auto. Reciprocate Min. Stroke	8 mm
Manual Distance	160 mm	Feed of One Turn of Handwheel (2-step)	20 mm (2 mm)
Auto Rapid Advance	40 mm	Motor	
Sliding Seat Supplementary Displacement	95 (total 295 mm)	Wheel Spindle	3.7 kw (4 P)
Min. Setting Unit (Micro-adjust)	0.001 mm	Workhead Spindle	1.3 / 2.0 kw
One Turn of Handwheel (graduation)	2 (0.005) mm	Hydraulic Pump	0.37 kw (4 P)
Grinding Wheel		Wheel Spindle Lubrication Pump	0.18 kw (4 P)
O.D. x Width x I.D.	405 x 50 x 127 mm	Coolant Pump	0.18 kw (2 P)
Speeds (belt type) r.p.m.	1783 / 1940	Internal Grinding Spindle	0.75 kw (2 P)
Work Spindle Head		Tank Capacity	
Swivel Angle	120° (+90°, -30°)	Wheel Spindle Lubricant Tank	9ℓ
Center Taper	MT:4	Hydraulic Fluid Tank	63ℓ
Spindle Speeds (variable) r.p.m.	10 ~ 300	Coolant Tank	110ℓ
Max. Load of Spindle (tool holder included)	35 kgs (Max length: 150 mm)	Machine Weight	
		Kgs	3200 kgs / 3400 kgs

SPECIFICATIONS	GU32/42x150S / GU32/42x200S	SPECIFICATIONS	GU32/42x150S / GU32/42x200S
Capacity		Tailstock	
Distance between Centers	1500 mm, 2000 mm	Taper Center	MT:4
Swivel Over Table	320 mm / 420 mm	Stroke	25 mm
Max. Load of Centers	100 kgs / 150 kgs	Table	
Max. External Grinding Diameter	300 mm / 400 mm	Swivel Angle	-3°, +7° (150 Type); -1°, +7° (200 Type)
Wheel Head		Traverse Speed	50 / 5400 mm/min
Swivel Angle	±30°	Auto. Reciprocate Min. Stroke	8 mm
Manual Distance	160 mm	Feed of One Turn of Handwheel (2-step)	20 mm (2 mm)
Auto Rapid Advance	40 mm	Motor	
Sliding Seat Supplementary Displacement	95 (total 295 mm)	Wheel Spindle	3.7 kw (4 P)
Min. Setting Unit (Micro-adjust)	0.001 mm	Workhead Spindle	1.3 / 2.0 kw
One Turn of Handwheel (graduation)	2 (0.005) mm	Hydraulic Pump	0.37 kw (4 P)
Grinding Wheel		Wheel Spindle Lubrication Pump	0.18 kw (4 P)
O.D. x Width x I.D.	405 x 50 x 127 mm	Coolant Pump	0.18 kw (2 P)
Speeds (belt type) r.p.m.	1783 / 1940	Internal Grinding Spindle	0.75 kw (2 P)
Work Spindle Head		Tank Capacity	
Swivel Angle	120° (+90°, -30°)	Wheel Spindle Lubricant Tank	9ℓ
Center Taper	MT:4	Hydraulic Fluid Tank	63ℓ
Spindle Speeds (variable) r.p.m.	10 ~ 300	Coolant Tank	110ℓ
Max. Load of Spindle (tool holder included)	35 kgs (Max length: 150 mm)	Machine Weight	
		Kgs	4100 kgs / 4300 kgs / 6000 kgs / 6200 kgs

• The mentioned specifications & dimensions are subject to change without notice.

Floor Space Occupied and Machine Dimensions

S Series

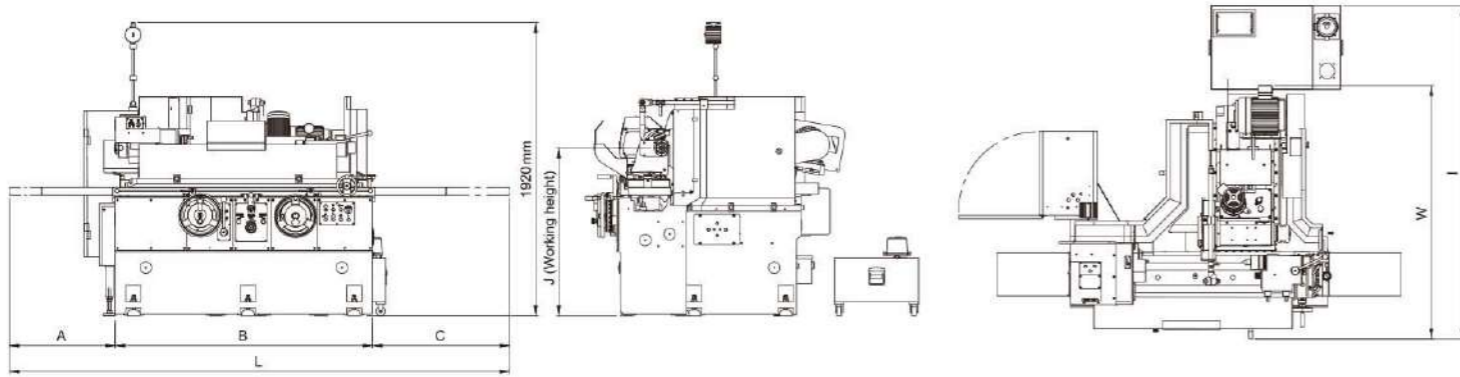

Unit: mm

MODEL	A	B	C	L	W	I	J
20 x 40	515	1320	480	2315	1434	2019	1060
32 x 60 / 42 x 60	694	1685	900	3279	1660	2185	1100/1150
32 x 100 / 42 x 100	1086	2465	1125	4676	1660	2185	1100/1150
32 x 150 / 42 x 150	1202	3810	1342	6354	1620	2200	1100/1150
32 x 200 / 42 x 200	1432	5210	1557	8199	1620	2200	1100/1150

NC Series

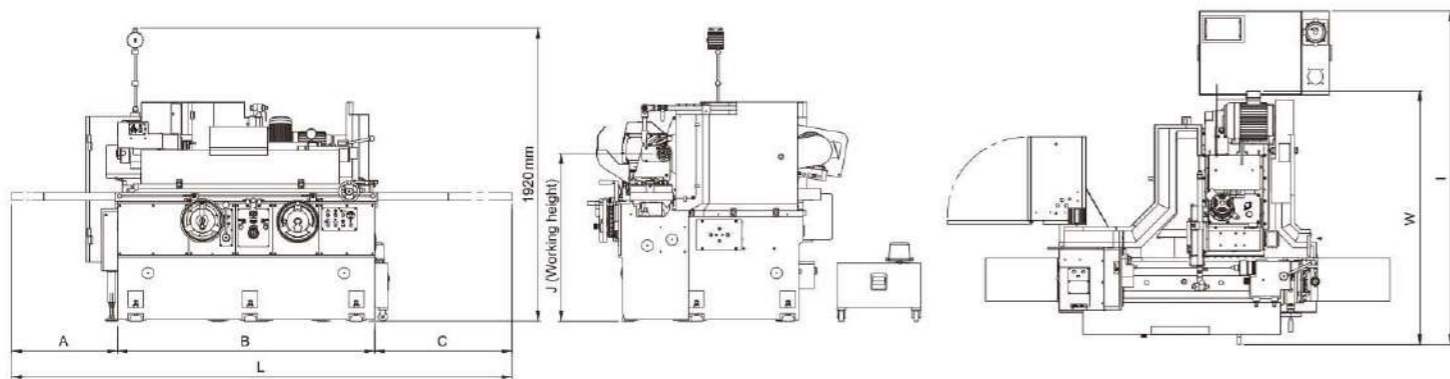

Unit: mm

MODEL	A	B	C	L	W	I	J
20 x 40	515	1320	480	2315	1434	2019	1060
32 x 60 / 42 x 60	694	1685	900	3279	1660	2185	1100/1150
32 x 100 / 42 x 100	1086	2465	1125	4676	1660	2185	1100/1150
32 x 150 / 42 x 150	1202	3810	1342	6354	1620	2200	1100/1150
32 x 200 / 42 x 200	1432	5210	1557	8199	1620	2200	1100/1150

Standard Accessories



1. Grinding wheel and flange x 1 set
2. Diamond tool holder (Table mounted type) x 1 pc
3. Carbide tipped work centers x 2 pcs
4. Coolant system x 1 set
5. Hydraulic system x 1 set



6. Work lamp x 1 pc
7. Tools and tool box x 1 set

Optional Accessories



1. Internal grinding attachment (including one spindle)
2. Diamond tool holder for internal and external grinding wheel dressing (upward open type)



3. Diamond tool holder (Tailstock mounted type)
4. Diamond tool holder for internal and external grinding wheel dressing (sideward open type)
5. Angle trimming device
6. Radius trimming device
7. Cam locked driving dogs (6 pcs/set)



8. Work steady rest (2 pcs/set)
9. 2-point steady rest
10. 3-point steady rest
11. Adjustable 3-jaw scroll chuck
12. Adjustable 4-jaw scroll chuck



13. Magnetic coolant separator
14. Magnetic coolant separator with paper filter
15. Wheel forming device (Manual type, without auto compensation)
16. Wheel forming device (For NC model, with auto compensation)
17. Wheel balancing stand and arbor

Rigorous Quality Inspection

● PALMARY's Q.C. department is fully equipped with comprehensive high precision inspection instruments, providing in-process and final product inspections. These precision instruments enable us to achieve the highest levels of quality. PALMARY cylindrical grinders are fully satisfied to every customer around the world. This achievement results from our tradition of "Insisting on Quality."



Internal Grinding Spindle

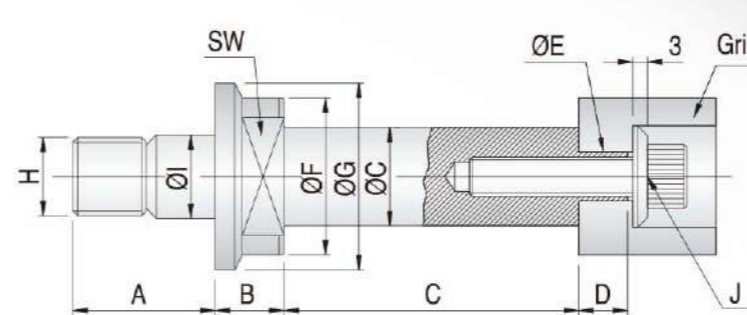

- The ratio of grinding hole diameter to length is 1 : 3.
- Maximum length is 150 mm.

Grinding	Grease type	A	B	C	D	E	F	G	H	I	J	SW
Ø65 ~ Ø150	8,000rpm	42	16	Ø40 x 100 Ø40 x 85 Ø40 x 55	12	Ø12	Ø50	Ø58	M26 x 2P	Ø28	M8 x 1.25P	41
Ø40 ~ Ø80	10,000rpm	29	14	Ø30 x 90 Ø25 x 70 Ø20 x 60	10	Ø10	Ø32	Ø38	M16 x 1.5P	Ø17	M8 x 1.25P	24
Ø35 ~ Ø70	15,000rpm	29	14	Ø30 x 90 Ø25 x 70 Ø20 x 60	10	Ø10	Ø32	Ø38	M16 x 1.5P	Ø17	M8 x 1.25P	24
Ø24 ~ Ø40	20,000rpm	28	11	Ø24 x 80 Ø20 x 60 Ø16 x 40	8	Ø8	Ø26	Ø32	M14 x 1.5P	Ø15	M6 x 1.0P	19
Ø15 ~ Ø25	30,000rpm	21	9	Ø16 x 40 Ø13 x 30 Ø10 x 25	6	Ø6	Ø21	Ø26	M10 x 1.5P	Ø10.5	M4 x 0.7P	17
Ø12 ~ Ø16	40,000rpm	20	8	Ø12 x 35 Ø10 x 30 Ø8 x 25	x	x	Ø18	Ø23	M8 x 1.25P	Ø8.5	M4 x 0.7P	14
Ø9 ~ Ø13	50,000rpm	18	7	Ø8 x 30 Ø7 x 25 Ø6 x 20	x	x	Ø15	Ø20	M7 x 1P	Ø7.5	M4 x 0.7P	11



Rotary-type Internal Grinding Attachment (Optional Accessory)

- Easy to change over from O.D. grinding to I.D. grinding. The attachment is fixed by the rotary support for convenient workpiece loading.
- To position the internal grinding attachment, simply turn it downward and fix it in the grinding position.
- Allows for external and internal grinding operations in one process.
- Tapered workpieces can be ground by swiveling on the workhead and table.
- The internal grinding attachment on the GU20 series is driven by a 1/2 HP motor.
- The internal grinding attachment on the GU32/42 series is driven by a 1HP motor.